

Installation Instructions

1. Mounting factory supplied weld rings: Mount the factory supplied weld ring on the pipe end using the *Shurjoint* ring clamp, C-clamp or other device to secure and position the ring in place. **Prior to welding make sure that the "L" dimension (the distance between the pipe end and the ring) is as specified for the coupling / pipe size.**

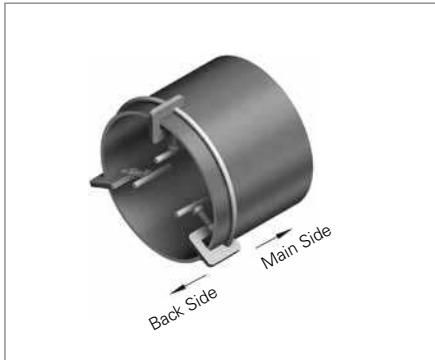

2. Step one welding: First weld the butt ends of the ring together. Next tack weld the ring to the pipe at several locations. Remove the ring clamps or other positioning devices.



3-1. Step two welding: Determine the type of weld required, full or partial, depending on the intended system working pressure. Refer to page 11 for working pressures and full and partial welding information. Weld the ring to the pipe using the proper weld(s) for the intended service.

Full & Partial Ring Welding: The *Shurjoint* Model R-88 Ring Joint Coupling is supplied with factory weld rings and is designed for a variety of service and pressure applications. For lower pressure applications weld rings need not be fully welded around the entire circumference of the pipe. The table shows the minimum required weld length in inches or millimeters and corresponding working pressures. Working pressures are based on the use of applicable pipe wall thickness for the service pressure intended.

Full welding means both sides of the weld ring are fully welded around the circumference of the pipe. One side shall be referred to as the "Main Weld" and the other side as "Back Weld". Either side of the weld ring can receive the Main Weld.

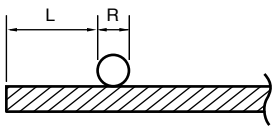

Welding conditions:

Method: SMAW (Shielded metal arc welding)*

Electrode: Flux-cored electrode $\frac{3}{32}$ " (2.4mm) to $\frac{1}{8}$ " (3.2mm)

Welding speed: 12" (300mm) to 16" (400mm) per minute

Current: 110A – 160A

Rotate pipe so that you can keep your electrode holder at the same position.

*GTAW or FCAW is also acceptable.

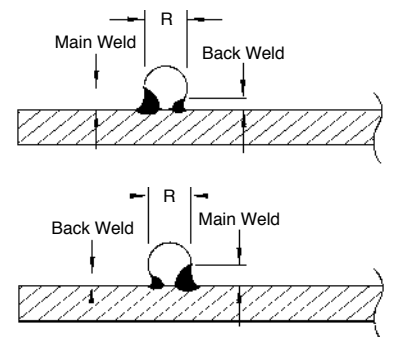
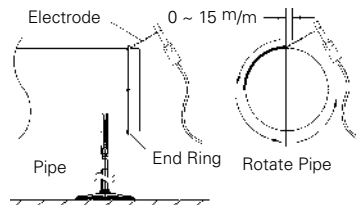

3-2. Partial weld: Partial ring welding will provide sufficient strength for lower pressure services. In case of partial ring welding, the weld shall be processed on the backside (away from the pipe end) of the ring.

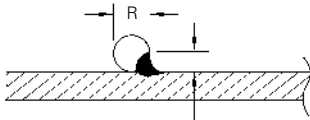

An equal alternating or zigzag weld is acceptable. Welds should be equal length and evenly spaced. Back welding provides additional strength to a partial weld.

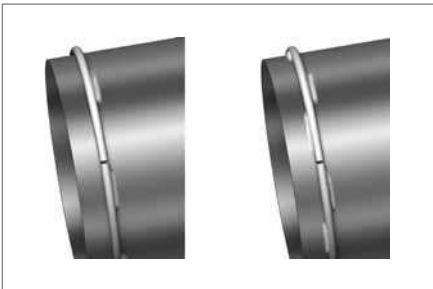

The fillet size of the Main Weld should measure a minimum of one half of the end ring size. The Back Weld should measure a minimum of one half of the Main Weld size.

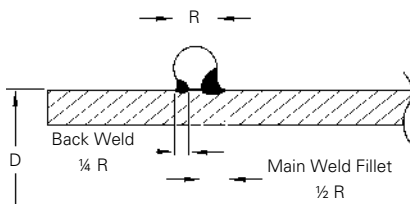

Standard End Ring & Fillet Size

Unit: Inch (mm)

End Ring Size	Main Weld Size	Back Weld Size
1/4 (6.0)	1/8 (3.0)	1/16 (1.5)
9/32 (7.0)	9/64 (3.5)	9/128 (1.75)
5/16 (8.0)	5/32 (4.0)	5/64 (2)
3/8 (9.5)	3/16 (4.8)	3/32 (2.4)
1/2 (12.0)	1/4 (6.0)	1/8 (3)
5/8 (16.0)	5/16 (8.0)	5/32 (4)
3/4 (19.0)	3/8 (9.5)	3/16 (4.75)

Working Pressure / Full & Partial Ring Welding

Minimum required weld length in inches (mm) and corresponding working pressures in psi (bar) for applicable steel pipe*.

Nominal Size in / mm	Weld Length - in / mm			
	< 125 psi < 9 bar	< 175 psi < 12 bar	< 300 psi < 20 bar	350 psi < 24 bar <
8 / 200	10 / 254	14 / 356	20 / 508	Full
10 / 250	12 / 305	20 / 508	30 / 762	Full
12 / 300	16 / 406	24 / 610	36 / 914	Full
14 / 350	18 / 457	28 / 711	40 / 1016	Full
16 / 400	22 / 559	32 / 813	Full	Full
18 / 450	28 / 711	40 / 1016	Full	Full
20 / 500	30 / 762	44 / 1118	Full	Full
24 / 600	40 / 1016	56 / 1422	Full	Full
26 / 650	42 / 1067	60 / 1524	Full	Full
28 / 700	44 / 1118	62 / 1575	Full	Full
30 / 750	48 / 1219	70 / 1778	Full	Full
32 / 800	50 / 1270	76 / 1930	Full	Full
34 / 850	54 / 1372	80 / 2032	Full	Full
36 / 900	68 / 1727	88 / 2235	Full	Full
38 / 950	76 / 1930	94 / 2388	Full	Full
40 / 1000	78 / 1981	102 / 2591	Full	Full
42 / 1050	81 / 2057	106 / 2692	Full	Full
44 / 1100	90 / 2286	114 / 2896	Full	Full
48 / 1200	110 / 2794	130 / 3302	Full	Full
52 / 1300	136 / 3454	Full	Full	Full
54 / 1350	140 / 3556	Full	Full	Full
56 / 1400	150 / 3810	Full	Full	Full
60 / 1500	164 / 4166	Full	Full	Full
66 / 1650	Full	Full	Full	Full
68 / 1700	Full	Full	Full	Full
72 / 1800	Full	Full	Full	Full
84 / 2100	Full	Full	Full	Full
96 / 2400	Full	Full	Full	Full

1. Applicable to Model R-88 couplings only.
2. "Full" welding means both sides of the weld ring are fully welded, all others are welded one side only.
3. * Refer to Max. Internal Service Pressure of Carbon Steel Pipe, ASTM A53 Gr. B table on page 9.

4. Quick check guide: After welding use an R-88 housing segment as a gauge to check the weld size by ensuring full and smooth engagement. The housing ring pocket must fully engage the ring without interference from the weld or fillet material.



Housing Segment

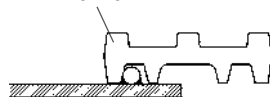

Quick Check

Fillets unacceptable:

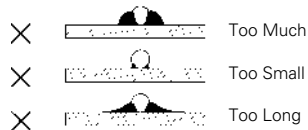

5. Weld the second ring: Repeat step 3 and weld the second ring to the other pipe end to be connected.



6. Apply a rust prevention coating: After welding apply a thin smooth coat of a rust prevention resin paint coating to the rings, weld areas and pipe ends. A fast drying paint is preferred.

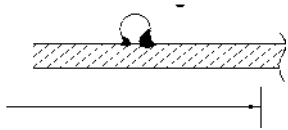

8. Align the pipe ends to be connected: Bring the mating pipes together and align the pipe ends. Turn the gasket back over the ring and center the gasket over the pipe ends and between the rings.

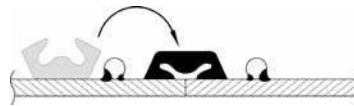

10. Tighten bolts and nuts: Install all bolts and nuts hand tight making sure the oval neck of the bolt fully engages into the housing bolt hole. Tighten nuts alternately and equally until all bolt pads come metal to metal.



Recommended Torque

Bolt size x number	Lbs - Ft (Nm)
5/8" x 6	100 - 130 (136 - 176)
3/4" x 6	150 - 200 (203 - 271)
7/8" x 8	180 - 220 (244 - 298)
1" x 16	200 - 250 (271 - 339)
1 1/4" x 16	250 - 350 (339 - 475)
1 1/2" x 16	350 - 500 (475 - 678)

Note: For systems subject to vibration or movement the use of Belleville washers or periodic checks to ensure tightness of bolts and nuts are recommended.

7. Lubricate and install gasket: Apply a thin coat of *Shurjoint* lubricant to the gasket exterior and sealing lips. Install the gasket over one pipe end. Turn the gasket inside out over the ring.



9. Install the coupling segments: Place the coupling segments over gasket so that the housing engages both rings. For larger size couplings, multiple segments can be loosely pre-assembled to aid in installation.



Warning – Always depressurize and drain the piping system before attempting to install, remove, adjust, or repair any *Shurjoint* piping component. Failure to comply with these instructions could lead to joint failure or resulting in serious personal injury, product and or property damage.



NOTE:
Non-destructive testing is not required by *Shurjoint*. Proper assembly of the rings, to which this would fall under, is the responsibility of the contractor/installer and is ultimately their decision regarding any standard, testing, or qualification of the welding personnel. Generally accepted piping and welding practices should be followed.