



Ring Joint Piping System

An excellent alternate
to grooving, flanges
and welding

Shurjoint Ring Joint Piping System

The **Shurjoint** ring joint piping system is a non-grooved mechanical pipe joining method and an excellent alternative where pipe is difficult to groove or when grooving, flanges or welding is not the preferred method. The ring joint coupling can be installed 3 - 4 times faster than a comparable welded or flanged joint.

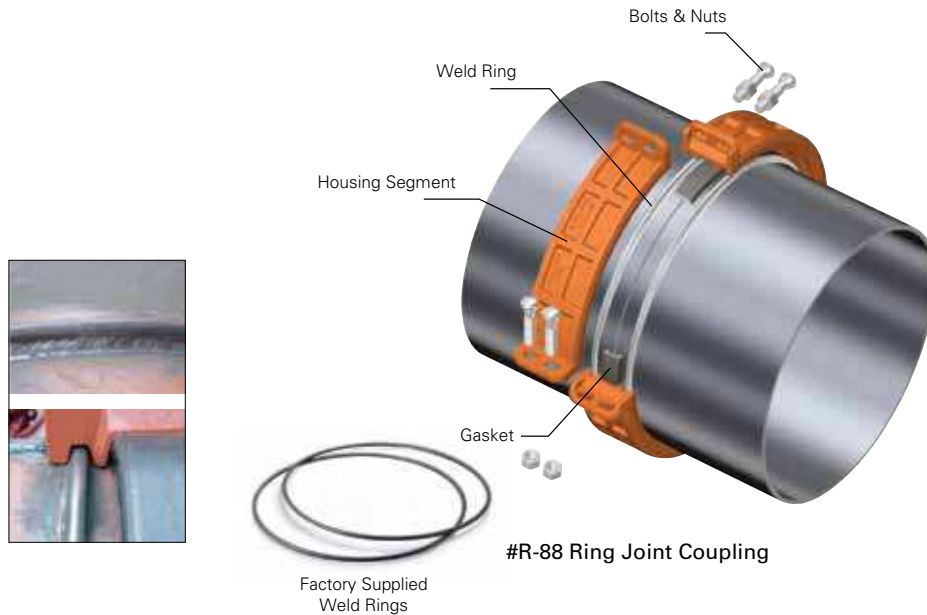

Hydrostatic testing - 72" R-88 coupling

The processing of a roll groove on pipe becomes more difficult as the pipe O.D. and wall thickness increases. Roll grooving pipe larger than 14" (350mm) requires proper tools and equipment. Pipe having a wall thickness greater than 0.375" (9.5mm) may not be practical to roll groove.

The **Shurjoint** ring joint coupling is supplied complete with a pair of factory supplied weld rings. For installation, weld a ring on each pipe end to be connected, next mount the rubber gasket over the pipe ends, place coupling segments over the gasket and fasten the bolts and nuts.

The **Shurjoint** ring joint coupling is considered a shouldered coupling, with the factory-supplied rings serving as the joint shoulders. The performance stan-

dards meet and or exceed the requirement of ASTM F1476 and AWWA C606. The factory supplied weld rings offer a much more economical and installation friendly alternative to that of traditional shoulder rings, including Type A, B, C, D, E and G rings.

The **Shurjoint** ring joint coupling provides a much more secure joint than that of a comparable standard roll or cut-grooved joint, while maintaining full bore flow and full pipe-wall thickness, which is often required in abrasive media applications. Each joint also serves as a union, making for easy, assembly, disassembly, service and system expansion. Custom high pressure couplings with working pressures to 3770 psi (260 bar) are also available.

Ring joint couplings can also be used on stainless steel pipe and are available with optional compatible grade stainless steel rings. Contact **Shurjoint** for details and availability.

Typical applications include:

- Water & Waste Water Treatment Plants
- Mining & Tunnel Boring
- Pulp & Paper
- Hydroelectric Plants
- Co-Gen Electric Plants
- Food & Beverage
- Compressed Air
- HVAC

Model R-88 Ring Joint Coupling

The *Shurjoint* Model R-88 Ring Joint Coupling is available in sizes 8"/200mm and above. Sizes 14"/350mm to 26"/650mm are now available either in a two-segment style (R-88N) or multi-segment style (R-88). The two-segment style offers an easier and faster installation.



A 28" R-88 coupling installed in a chilled water system.

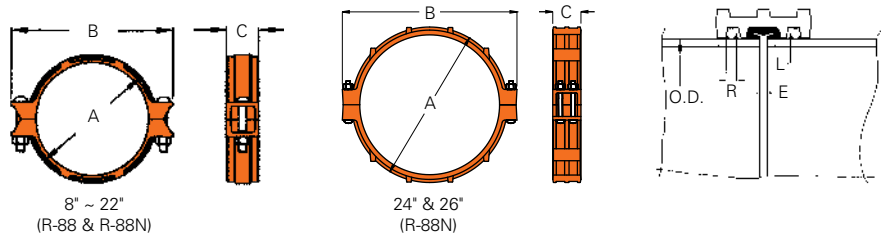

Nominal Size in / mm	Pipe OD in / mm	Rings both sides fully welded**			Axial Displacement † E in / mm	Angular Movement / Deflection †		Dimensions			Bolt No. & Size	Sealing Surface L in / mm	Ring Size R in / mm	N.W. Lbs / Kgs
		Max. Working Pressure (CWP)* psi / Bar	ASME/ANSI Pressure Class Rating^ @ 100°F/ @ 38°C psi / Nom. Class	Max. End Load (CWP) Lbs / kN		Per Cplg Deg. (°)	Per Pipe in / ft / mm / m	A in / mm	B in / mm	C in / mm				
8	8.625	400	400	23350	0-0.190	2.14	0.45	10.08	13.00	3.11	2 - 3/4 x 4 1/2	0.91	1/4	16.8
200	219.1	28.0	250	105.51	0-4.8			37	256	330				
10	10.750	400	400	36280	0-0.190	1.95	0.41	12.29	15.20	3.25	2 - 3/4 x 4 1/2	0.91	1/4	22.2
250	273.0	28.0	250	163.81	0-4.8			34	312	386				
12	12.750	400	400	51040	0-0.190	0.82	0.17	14.72	17.90	3.39	2 - 7/8 x 6 1/2	1.02	5/16	30.8
300	323.9	28.0	250	230.59	0-4.8			14	374	455				
200 JIS	8.516	400	400	22770	0-0.190	1.50	0.31	9.96	12.87	3.11	—	0.91	1/4	17.6
	216.3	28.0	250	102.83	0-4.8			26	253	327				
250 JIS	10.528	400	400	34800	0-0.190	1.50	0.31	12.05	14.96	3.25	—	0.91	1/4	22.0
	267.4	28.0	250	157.16	0-4.8			26	306	380				
300 JIS	12.539	400	400	49360	0-0.190	1.50	0.31	14.53	17.72	3.39	—	1.02	5/16	32.6
	318.5	28.0	250	222.97	0-4.8			26	369	450				
14	14.000	400	400	61540	0-0.250	1.20	0.25	15.93	19.40	3.65	2 - 7/8 x 5 1/2	1.02	5/16	38.3
350 (R-88N)	355.6	28.0	250	277.94	0-6.4			21	405	493				
16	16.000	400	400	80380	0-0.250	0.90	0.19	17.92	21.52	3.65	2 - 7/8 x 5 1/2	1.02	5/16	35.0
400 (R-88N)	406.4	28.0	250	363.02	0-6.4			16	455	547				
18	18.000	400	400	101730	0-0.375	1.20	0.25	20.37	24.17	4.23	2 - 1 x 5 1/2	1.18	5/16	50.6
450 (R-88N)	457.2	28.0	250	459.45	0-9.5			21	517	614				
20	20.000	400	400	125600	0-0.375	1.08	0.23	22.46	25.99	4.35	2 - 1 x 5 1/2	1.18	3/8	68.7
500 (R-88N)	508.0	28.0	250	567.22	0-9.5			19	570	660				
24	24.000	400	400	180860	0-0.375	0.80	0.17	27.17	30.00	4.84	4 - 7/8 x 6 1/2	1.18	1/2	104.7
600 (R-88N)	609.6	28.0	250	816.80	0-9.5			14	690	762				
26	26.000	300	300	159190	0-0.500	1.06	0.22	29.58	32.78	6.69	4 - 1 x 8 7/8	1.97	1/2	173.5
650 (R-88N)	660.4	20.0	150	684.72	0-12.7			18	751	832				

R-88N is a two-segment type coupling.

Dimensions are subject to change without notice. Other sizes are available on request.

Working Pressure and End Load are the total from all internal and external loads based on the applicable pipe wall thickness.

** Working Pressure is based on rings both sides fully welded standard wall carbon steel pipe.

† Allowable Axial Displacement and Angular Movement (Deflection) figures shown are the maximum nominal range of movement at each R-88 coupling joint when rings are welded in the standard position. For design and installation purposes these figures should be reduced by 25%.

^ The ASME/ANSI pressure class rating is not the design or maximum pressure rating, rather is provided for those that are accustomed to specifying or using ASME/ANSI pressure class rated components such as flange, valves, etc.

‡ Bolt & nuts are UNC threaded.

Model R-88 Ring Joint Coupling (Large diameter)



R-88
Size: 48"

The *Shurjoint* Model R-88 Ring Joint Coupling is available in sizes 28"/700mm to 96"/2400mm. The larger diameter couplings are comprised of 4 to 8 housing segments depending on the size and feature two bolts at each joint segment to ensure a positive connection.

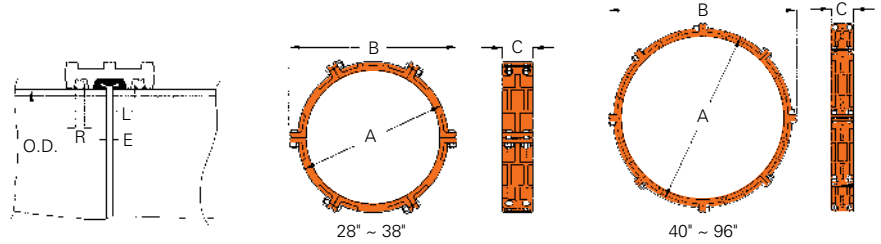

Nominal Size in / mm	Pipe OD in / mm	Rings both sides fully welded**			Axial Displacement † E in / mm	Angular Movement / Deflection †		Dimensions			Bolt No. & Size No. in	Sealing Surface L in / mm	Ring Size R in / mm	N.W. Lbs / Kgs
		Max. Working Pressure (CWP)* psi / Bar	ASME/ANSI Pressure Class Rating [^] @ 100°F/ @ 38°C psi / Nom. Class	Max. End Load (CWP) Lbs / kN		Per Cplg Deg. (°)	Per Pipe in / ft / mm / m	A in / mm	B in / mm	C in / mm				
28	28.0	300	300	184630	0-0.500	0.90	0.19	31.75	35.50	6.73	12 - 7/8 x 4	2.00	1/2	222.2
700	711.2	20.0	150	794.11	0-12.7		16	806	902	171		50	12.7	101.0
30	30.0	300	300	211950	0-0.500	0.86	0.18	33.75	37.60	6.73	12 - 1 x 3 1/2	2.00	1/2	218.9
750	762.0	20.0	150	911.61	0-12.7		15	857	955	171		50	12.7	99.5
32	32.0	300	300	241150	0-0.500	0.84	0.18	35.75	39.50	6.73	12 - 1 x 3 1/2	2.00	1/2	225.4
800	812.8	20.0	150	1037.21	0-12.7		15	908	1003	171		50	12.7	102.2
34	34.0	300	300	272230	0-0.500	0.84	0.18	37.75	41.50	6.73	12 - 1 x 3 1/2	2.00	1/2	253.0
850	863.4	20.0	150	1170.37	0-12.7		15	959	1054	171		50	12.7	115.0
36	36.0	300	300	305200	0-0.500	0.76	0.16	39.75	43.50	6.73	12 - 1 x 3 1/2	2.00	1/2	246.0
900	914.4	20.0	150	1312.72	0-12.7		13	1010	1103	171		50	12.7	111.6
38	38.0	232	175	262980	0-0.500	0.76	0.16	41.75	45.50	6.73	12 - 1 x 3 1/2	2.00	1/2	275.0
950	965.2	16.0	125	1170.10	0-12.7		13	1060	1156	171		50	12.7	125.0
40	40.0	232	175	291390	0-0.625	0.80	0.17	44.69	48.39	7.80	16 - 1 x 3 1/2	2.37	5/8	310.2
1000	1016.0	16.0	125	1296.51	0-15.9		14	1135	1229	198		60	15.9	141.0
42	42.0	232	175	321250	0-0.625	0.86	0.18	46.70	50.39	7.80	16 - 1 1/4 x 5	2.37	5/8	326.9
1050	1066.8	16.0	125	1429.41	0-15.9		15	1186	1280	198		60	15.9	148.6
44	44.0	232	175	352580	0-0.625	0.80	0.17	48.66	51.89	7.80	16 - 1 1/4 x 5	2.37	5/8	343.2
1100	1117.6	16.0	125	1568.78	0-15.9		14	1236	1318	198		60	15.9	156.0
48	48.0	232	175	419600	0-0.625	0.70	0.15	52.68	55.91	7.80	16 - 1 x 3 1/2	2.37	5/8	466.7
1200	1219.2	16.0	125	1866.98	0-15.9		12	1338	1420	198		60	15.9	211.8
52	52.0	175	175	371460	0-0.625	--	--	61.25	60.60	7.80	16 - 1 1/4 x 5	2.37	5/8	453.2
1300	1320.8	12.0	125	1643.33	0-15.9	--	--	63.25	62.60	7.80	16 - 1 1/4 x 5	2.37	5/8	472.1
54	54.0	175	175	400580	0-0.625	--	--	63.25	62.60	7.80	16 - 1 1/4 x 5	2.37	5/8	472.1
1350	1371.6	12.0	125	1772.17	0-15.9	--	--	1660	1590	198		60	15.9	214.6
56	56.0	175	175	430800	0-0.625	--	--	65.38	64.60	7.80	16 - 1 1/4 x 5	2.37	5/8	488.2
1400	1422.4	12.0	125	1905.87	0-15.9	--	--	1660	1641	198		60	15.9	222.0
60	60.0	175	175	494550	0-0.625	--	--	69.38	68.60	7.80	16 - 1 1/4 x 5	2.37	5/8	537.2
1500	1524.0	12.0	125	2187.87	0-15.9	--	--	1762	1742	198		60	15.9	244.2
66	66.0	125	175	427430	0-0.750	--	--	76.00	75.79	8.00	16 - 1 1/2 x 5	2.37	3/4	612.5
1650	1676.4	8.6	125	1897.24	0-19.1	--	--	1932	1925	216		60	19.1	278.4
68	68.0	125	175	453730	0-0.750	--	--	78.50	77.79	8.00	16 - 1 1/2 x 5	2.37	3/4	785.4
1700	1727.2	8.6	125	2013.97	0-19.1	--	--	1994	1976	216		60	19.1	357.0
72	72.0	125	175	508680	0-0.750	--	--	82.50	81.81	8.00	16 - 1 1/2 x 5	2.37	3/4	737.7
1800	1828.8	8.6	125	2257.88	0-19.1	--	--	2095	2078	216		60	19.1	335.3
84	84.0	100	175	553890	0-0.750	--	--	94.75	93.81	8.00	16 - 1 1/2 x 5	2.37	3/4	780.3
2100	2133.6	7.0	125	2501.46	0-19.1	--	--	2406	2383	216		60	19.1	354.7
96	96.0	100	175	723450	0-0.750	--	--	106.75	105.79	8.00	16 - 1 1/2 x 5	2.37	3/4	823.2
2400	2438.4	7.0	125	3267.21	0-19.1	--	--	2711	2662	216		60	19.1	374.2

Dimensions are subject to change without notice. Other sizes are available on request.

Working Pressure and End Load are the total from all internal and external loads based on the applicable pipe wall thickness.

**Working Pressure is based on rings both sides fully welded standard wall carbon steel pipe.

† Allowable Axial Displacement and Angular Movement (Deflection) figures shown are the maximum nominal range of movement at each R-88 coupling joint when rings are welded in the standard position. For design and installation purposes these figures should be reduced by 25%.

[^] The ASME/ANSI pressure class rating is not the design or maximum pressure rating, rather is provided for those that are accustomed to specifying or using ASME/ANSI pressure class rated components such as flange, valves, etc.

Model RH-1000 1000 PSI Ring Joint Coupling

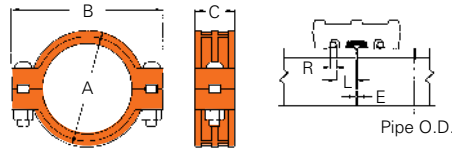

The *Shurjoint* Model RH-1000 coupling is a high pressure ring joint coupling for use with Sch. 40, Sch. 80 and heavier wall carbon steel pipes. The coupling is comprised of two ductile iron heavy-

wall housing segments, rubber gasket (EPDM or Nitrile) and two heat treated track bolts and nuts which provide a fully restrained joint and a maximum working pressure of 1,000 psi (70 Bar) depending

on the pipe used. Two steel weld rings are factory supplied with the coupling. Steel rings must always be fully welded on both sides.



Nominal Size in / mm	Pipe OD in / mm	Max. Working Pressure (CWP)* psi / Bar	ASME/ANSI Pressure Class Rating [^] @ 100°F / @ 38°C psi / Nom. Class	Max. End Load (CWP) Lbs / kN	Dimensions			Bolt / Nut †		Deflection Deg.	Pipe-end Preparation			Weight Lbs / Kgs
					A in / mm	B in / mm	C in / mm	No.	Size in		R in / mm	L in / mm	E (max) in / mm	
8	8.625	1000	1000	58390	11.10	14.65	3.86	2	1 x 5½	0° - 18'	0.472 - 0.500	1	0.13	39.8
200	219.1	70	400	263.79	282	372	98				12.0 - 12.7	25	3.2	18.1
10	10.750	1000	1000	90710	13.32	16.93	4.25	2	1 x 6½	0° - 38'	0.472 - 0.500	1	0.13	57.2
250	273	70	400	409.54	340	430	108				12.0 - 12.7	25	3.2	26.0
12	12.750	1000	1000	127610	16.33	20.07	4.17	2	1 x 6½	0° - 32'	0.472 - 0.500	1	0.13	72.6
300	323.9	70	400	576.49	415	510	106				12.0 - 12.7	25	3.2	33.0

* Working pressure is based on standard wall carbon steel pipe. † Bolt & nuts are UNC threaded.

[^] The ASME/ANSI pressure class rating is not the design or maximum pressure rating, rather is provided for those that are accustomed to specifying or using ASME/ANSI pressure class rated components such as flange, valves, etc.

Model RX-3000 3000 PSI Ring Joint Coupling

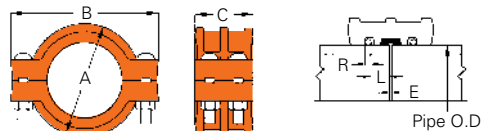

The *Shurjoint* RX-3000 coupling is a high pressure ring joint coupling for use with Sch. 80, 120 or heavier wall carbon steel pipelines.

The coupling is comprised of two ductile iron heavy-wall housings, rubber gasket

(EPDM or Nitrile) and two or four heat treated track bolts and nuts which provide a fully restrained joint with maximum working pressure up to 3,000 psi (210 Bar) depending on the pipe used. RX-3000 couplings should always be in-

stalled so that the coupling bolt pads make metal to metal contact.

Two steel weld rings will be factory supplied with the coupling. Steel rings shall always be always fully welded on both sides.

Nominal Size in / mm	Pipe OD in / mm	Max. Working Pressure (CWP)* psi / Bar	ASME/ANSI Pressure Class Rating [^] @ 100°F / @ 38°C psi / Nom. Class	Max. End Load (CWP) Lbs / kN	Dimensions			Bolt / Nut †		Pipe-end Preparation			Weight Lbs / Kgs
					A in / mm	B in / mm	C in / mm	No.	Size in	R in / mm	L in / mm	E (max) in / mm	
8	8.625	3000	3000	175180	11.81	15.51	5.83	2	1½ x 5½	0.472 ~ 0.500	1.22	½	78.92
200	219.1	210	1500	791.36	300	394	148			12.0 ~ 12.7	31	3	35.87
10	10.748	3000	3000	272040	14.96	18.93	5.98	4	1¼ x 6½	0.625 ~ 0.629	1.22	½	116.36
250	273.0	210	1500	1228.61	380	481	152			15.9 ~ 16.0	31	3	52.78
12	12.752	3000	3000	382950	18.50	22.48	6.81	4	1½ x 6¼	0.625 ~ 0.629	1.22	½	212.27
300	323.9	210	1500	1729.46	470	572	173			15.9 ~ 16.0	31	3	96.24

* Working pressure is based on API 5L X65 line pipe.

[^] The ASME/ANSI pressure class rating is not the design or maximum pressure rating, rather is provided for those that are accustomed to specifying or using ASME/ANSI pressure class rated components such as flange, valves, etc.

† Bolt & nuts are UNC threaded.

Model RX-3770 3770 PSI Ring Joint Coupling



The *Shurjoint* Model RX-3770 Ring Joint Coupling is designed to provide a fully restrained joint for use with extra-strong carbon steel pipe including API 5L Grade X65 line pipe.

The coupling is comprised of two ductile iron heavy-wall housing segments, rubber gasket (EPDM) and four heat-treated track bolts and nuts. Two steel weld rings are

factory supplied with the coupling. Steel rings must always be fully welded on both sides.



Proof and burst pressure testing

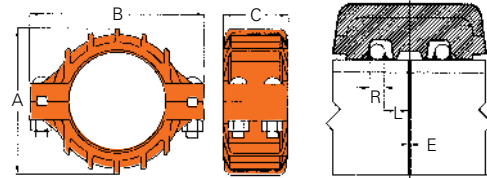

Nominal Size in / mm	Pipe OD in / mm	Max. Working Pressure (CWP)* psi / Bar	ASME/ANSI Pressure Class Rating^ @ 100°F / @ 38°C psi / Nom. Class	Max. End Load (CWP) Lbs / kN	Dimensions			Bolt / Nut ‡		Pipe-end Preparation			Weight Lbs / Kgs
					A in / mm	B in / mm	C in / mm	No.	Size in	R in / mm	L in / mm	E (max) in / mm	
6	6.625	3770	3770	129890	10.24	12.64	5.87	4	¾ x 6½	0.472	1.22	0.20	61.2
150	168.3	260	2000	578.11	260	321	149			12	31	5	27.7
8	8.625	3770	3770	220150	12.95	16.30	6.89	4	1½ x 6½	0.625	1.50	0.20	110.0
200	219.1	260	2000	979.78	329	414	175			16	38	5	49.9
10	10.750	3770	3770	342000	15.90	19.88	7.40	4	1½ x 6⅞	0.750	1.50	0.20	174.5
250	273.0	260	2000	1521.14	404	505	188			19	38	5	79.2
12	12.750	3770	3770	481090	19.00	23.10	8.63	4	1½ x 6⅞	0.875	1.50	0.24	247.1
300	323.9	260	2000	2141.24	482	587	219			22	38	6	112.3

* Working pressure is based on API 5L X65 line pipe.

^ The ASME/ANSI pressure class rating is not the design or maximum pressure rating, rather is provided for those that are accustomed to specifying or using ASME/ANSI pressure class rated components such as flange, valves, etc.

‡ Bolt & nuts are UNC threaded.

Ring Joint Fittings Model

RJ-10 90° Elbow
RJ-11 45° Elbow

RJ-20 Tee
RJ-60 Cap

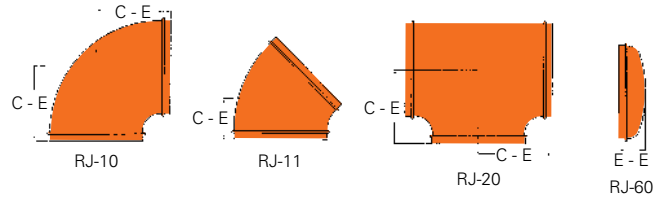

Shurjoint offers a full range of ring joint fittings for use with Model R-88 ring joint couplings.

- 8" - 16" (200mm – 400mm) Models RJ-10, RJ-11 & RJ-60 and Model RJ-20

are available in cast ductile iron to ASTM A536 Gr. 65-45-12.

- Larger sizes are made of carbon steel standard weight pipe, ASTM A53 Gr. B or equivalent, or fabricated from wrought

carbon steel of the equivalent properties.

- Other configurations are also available upon request. Contact *Shurjoint* for details.

Nominal Size in / mm	Pipe OD in / mm	RJ-10 90° Elbow		RJ-11 45° Elbow		RJ-20 Tee		RJ-60 Cap	
		C - E in / mm	Weight Lbs / Kgs	C - E in / mm	Weight Lbs / Kgs	C - E in / mm	Weight Lbs / Kgs	E - E in / mm	Weight Lbs / Kgs
8	8.625	7.75	28.6	4.25	20.9	7.75	46.2	3.00	12.1
200	219.1	197	13.0	108	9.5	197	21.0	76	5.5
10	10.750	9.00	55.0	4.75	39.6	9.00	72.6	3.00	13.2
250	273.0	229	25.0	121	18.0	229	33.0	76	6.0
12	12.750	10.00	77.0	5.25	50.6	10.00	103.4	3.00	17.6
300	323.9	254	35.0	133	23.0	254	47.0	76	8.0
200 JIS	8.516	7.75	28.6	4.25	20.9	7.75	46.2	3.00	12.1
	216.3	197	13.0	108	9.5	197	21.0	76	5.5
250 JIS	10.528	9.00	55.0	4.75	39.6	9.00	72.6	3.00	13.2
	267.4	229	25.0	121	18.0	229	33.0	76	6.0
300 JIS	12.539	10.00	77.0	5.25	50.6	10.00	103.4	3.00	17.6
	318.5	254	35.0	133	23.0	254	47.0	76	8.0
14	14.000	11.00	81.4	6.00	52.8	11.00	118.8	4.00	26.4
350	355.6	280	37.0	152	24.0	280	54.0	102	12.0
16	16.000	12.00	99.0	7.25	101.2	12.00	154.0	4.00	33.0
400	406.4	305	45.0	184	46.0	305	70.0	102	15.0
18	18.000	27.00	209.0	11.25	105.6	15.50	268.0	5.00	46.2
450	457.2	686	95.0	286	48.0	394	122.0	127	21.0
20	20.000	30.00	203.6	12.50	110.0	17.25	337.0	6.00	57.2
500	508.0	762	138.0	318	50.0	438	153.0	152	26.0
24	24.000	36.00	485.0	15.00	176.0	20.00	466.0	6.00	77.0
600	609.6	914	220.0	381	80.0	508	212.0	152	35.0
26	26.000	39.00	521.0	16.00	262.0	22.50	766.0	10.50	110.0
650	660.4	991	237.0	406	119.0	572	348.0	267	50.0
28	28.000	42.00	605.0	17.25	304.0	23.50	862.0	10.50	123.0
700	711.2	1067	275.0	438	138.0	597	392.0	267	56.0
30	30.000	45.00	695.0	18.50	348.0	25.00	992.0	10.50	136.0
750	76.20	1143	316.0	480	158.0	635	451.0	267	62.0
32	32.000	48.00	792.0	19.75	396.0	26.50	1135.0	10.50	248.6
800	812.8	1219	360.0	502	180.0	673	516.0	267	113.0
34	34.000	51.00	895.0	21.00	449.0	28.00	1285.0	10.50	165.0
850	863.4	1295	407.0	533	204.0	711	584.0	267	75.0
36	36.000	54.00	1005.0	22.25	504.0	30.00	1445.0	10.50	334.4
900	914.4	1372	457.0	565	229.0	762	657.0	267	152.0
40	40.000	60.00	1241.0	24.88	620.0	33.00	1790.0	12.00	224.0
1000	1016.0	1524	564.0	632	282.0	838	814.0	305	102.0
42	42.000	63.00	1368.0	26.00	684.0	35.00	1841.0	12.00	242.0
1050	1066.8	1600	622.0	660	311.0	889	837.0	305	110.0
44	44.000	66.00	1503.0	27.39	752.0	36.00	2075.0	13.50	277.0
1100	1117.6	1676	683.0	696	342.0	914	943.0	343	126.0
48	48.000	72.00	1790.0	29.88	895.0	40.00	2488.0	13.50	315.0
1200	1219.2	1829	814.0	759	407.0	1016	1131.0	343	143.0

• C-E of RJ-10 and RJ-11 18" and larger sizes and E-E of RJ-60 26" and larger sizes conform to ANSI B16.9. All other sizes are to manufacturer's standard.

Ring Joint Fittings Model

RJ-21 Reducing Tee

RJ-50 Concentric Reducer

RJ-51 Eccentric Reducer

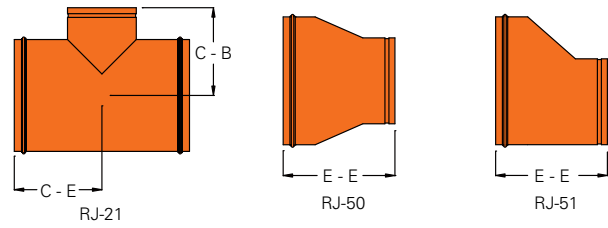

Nominal Size in / mm	Pipe OD in / mm	RJ-21 Reducing Tee			RJ-50 Conc. Reducer		RJ-51 Ecc. Reducer	
		C - E in / mm	C - B in / mm	Weight Lbs / Kgs	E - E in / mm	Weight Lbs / Kgs	E - E in / mm	Weight Lbs / Kgs
14 x 12	14.000 x 12.750	11.00	10.62	145.0	8.00	51.0	13.00	51.0
350 x 300	355.6 x 323.9	279	270	66.0	203*	23.0	330	23.0
16 x 12	16.000 x 12.750	12.00	11.62	172.0	9.00*	64.0	9.00*	64.0
400 x 300	406.4 x 323.9	305	295	78.0	229	29.0	229	29.0
16 x 14	16.000 x 14.000	12.00	12.00	176.0	9.00*	64.0	9.00*	64.0
400 x 350	406.4 x 355.6	305	305	80.0	229	29.0	229	29.0
18 x 12	18.000 x 12.750	13.50	12.62	246.0	9.50*	72.6	15.00	78.0
450 x 300	457.2 x 323.9	343	321	112.0	241	33.0	381	35.0
18 x 14	18.000 x 14.000	13.50	13.00	253.0	15.00	79.0	15.00	79.0
450 x 350	457.2 x 355.6	343	330	115.0	381	36.0	381	36.0
18 x 16	18.000 x 16.000	13.50	13.00	264.0	15.00	79.0	15.00	79.0
450 x 400	457.2 x 406.4	343	330	120.0	381	36.0	381	36.0
20 x 12	20.000 x 12.750	15.00	13.62	297.0	10.00*	95.0	20.00	95.0
500 x 300	508.0 x 323.9	381	346	135.0	254	43.0	508	43.0
20 x 14	20.000 x 14.000	15.00	14.00	304.0	20.00	99.0	20.00	99.0
500 x 350	508.0 x 355.6	381	356	138.0	508	45.0	508	45.0
20 x 16	20.000 x 16.000	15.00	14.00	317.0	20.00	101.0	20.00	101.0
500 x 400	508.0 x 406.4	381	356	144.0	508	46.0	508	46.0
20 x 18	20.000 x 18.000	15.00	14.50	328.0	20.00	128.0	20.00	128.0
500 x 450	508.0 x 457.2	381	368	149.0	508	58.0	508	58.0
24 x 12	24.000 x 12.750	17.00	15.62	396.0	12.00*	154.0	20.00	154.0
600 x 300	609.6 x 323.9	432	397	180.0	305	70.0	508	70.0
24 x 14	24.000 x 14.000	17.00	16.00	407.0	20.00	154.0	20.00	154.0
600 x 350	609.6 x 355.6	432	406	185.0	508	70.0	508	70.0
24 x 16	24.000 x 16.000	17.00	16.00	418.0	12.00*	154.0	20.00	154.0
600 x 400	609.6 x 406.4	432	406	190.0	305	70.0	508	70.0
24 x 18	24.000 x 18.000	17.00	16.50	433.0	20.00	154.0	20.00	154.0
600 x 450	609.6 x 457.2	432	419	197.0	508	70.0	508	70.0
24 x 20	24.000 x 20.000	17.00	17.00	444.0	12.00*	156.0	20.00	156.0
600 x 500	609.6 x 508.0	432	432	202.0	305	71.0	508	71.0

C-E: Mfr's standard. E-E marked (*): Mfr's standard (made of ductile iron). All other E-E: ANSI B16.9.

Model

RJ-70 Flange Adapter

ANSI Class 125/150

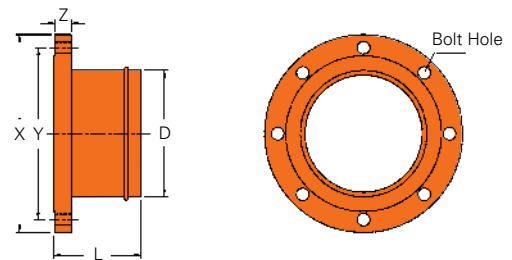

Nominal Size in / mm	Pipe O.D. D in / mm	RJ-70 Flange Adapter							
		X in / mm	Y in / mm	Z in / mm	Bolt Size in	Bolt Hole		L in / mm	Weight Lbs / Kgs
						Dia. in	No.		
8	8.625	13.500	11.750	1.125	3/4	7/8	8	6	44.9
200	219.1	343.0	298.0	29.0				152	20.4
10	10.750	16.000	14.250	1.180	7/8	1	12	8	67.1
250	273.0	406.4	362.0	30.0				203	30.5
12	12.750	19.000	17.000	1.250	7/8	1	12	8	98.1
300	323.9	483.0	432.0	32.0				203	44.6
14	14.000	21.000	18.750	1.377	1	1 1/8	12	8	118.8
350	355.6	533.0	476.25	35.0				203	54.0
16	16.000	23.500	21.250	1.456	1	1 1/8	16	8	147.0
400	406.4	597.0	539.75	37.0				203	66.8
18	18.000	25.000	22.751	1.059	1 1/8	1 1/4	16	8	143.0
450	457.2	635.0	577.9	26.9				203	65.0
20	20.000	27.519	25.000	1.692	1 1/8	1 1/4	20	8	169.4
500	508.0	699.0	635.0	43.0				203	77.0
24	24.000	32.031	29.500	1.889	1 1/4	1 3/8	20	8	286.9
600	609.6	813.6	749.3	48.0				203	130.4

L: Mfr's standard.

Large Diameter Ring Joint Fittings

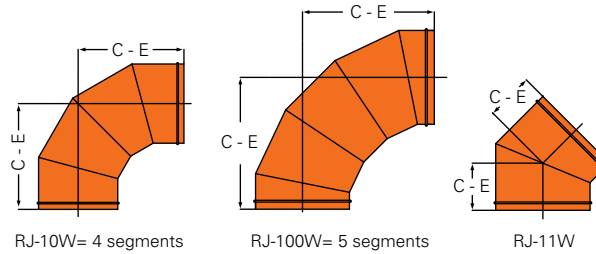

Shurjoint fabricated ring joint fittings are made of carbon steel, 0.375" (9.5mm) and 0.5" (12.7mm) wall, conforming to ASTM A53, Grade B, or equivalent. Additional ring joint fitting configurations

are available to accommodate almost any connection; ring to groove, ring to flange or ring to weld. Contact *Shurjoint* for further details.

Coatings:
 Standard: Rust inhibiting paint, orange color.
 Optional: Other color paint or hot-dip galvanized conforming to ASTM A153.

Nominal Size	Pipe OD	RJ-10W 90° Elbow, Standard Radius			RJ-100W 90° Elbow, Long Radius			RJ-11W 45° Elbow		
		C - E	Weight (t = 0.375" / 9.5 mm)	Weight (t = 0.5" / 12.7 mm)	C - E	Weight (t = 0.375" / 9.5 mm)	Weight (t = 0.5" / 12.7 mm)	C - E	Weight (t = 0.375" / 9.5 mm)	Weight (t = 0.5" / 12.7 mm)
in / mm	in / mm	in / mm	Lbs / Kgs	Lbs / Kgs	in / mm	Lbs / Kgs	Lbs / Kgs	in / mm	Lbs / Kgs	Lbs / Kgs
26	26.000	33.5	494	653	36.5	537	709	13	222	292
650	660.4	851	225	297	927	244	322	330	101	133
28	28.000	37.5	589	778	39.0	609	805	14	257	338
700	711.2	953	268	354	991	277	366	356	117	154
30	30.000	37.5	632	835	41.5	699	924	15	295	388
750	762.0	953	287	379	1054	318	420	381	134	176
32	32.000	37.5	674	891	44.0	791	1047	16	335	441
800	812.8	953	306	4055	1118	360	476	406	152	201
34	34.000	40.0	803	1064	46.5	886	1176	17	377	498
850	863.4	1016	365	484	1181	403	534	432	171	226
36	36.000	40.0	805	1065	49.0	990	1310	18	423	558
900	914.4	1016	366	484	1245	450	596	457	192	253
38	38.000	40.0	847	1047	51.5	1003	1331	19	480	636
950	965.2	1016	385	476	1308	456	605	483	218	289
40	40.000	43.5	937	1303	54.0	1160	1615	20	503	696
1000	1016.0	1105	426	592	1372	527	734	508	228	316
42	42.000	43.5	989	1369	56.5	1278	1774	21	555	767
1050	1066.8	1105	449	622	1435	581	807	533	252	349
44	44.000	43.5	1086	1435	59.5	1479	1958	22	638	841
1100	1117.6	1105	494	652	1511	672	890	559	290	382
46	46.000	45.0	1162	1577	51.5	1003	1331	23	790	904
1150	1168.4	1143	528	717	1308	456	605	584	319	411
48	48.000	45.0	1209	1610	64.0	1722	2296	24	752	999
1200	1219.2	1143	550	732	1626	783	1044	610	342	454

t: wall thickness

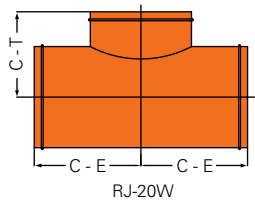

Nominal Size	Pipe OD	RJ-20W Tee			
		C - E	C - T	Weight (t = 0.375" / 9.5 mm)	Weight (t = 0.5" / 12.7 mm)
in / mm	in / mm	in / mm	in / mm	Lbs / Kgs	Lbs / Kgs
26	26.000	19.5	19.5	779	1025
650	660.4	495	495	354	466
28	28.000	20.5	20.5	877	1154
700	711.2	521	521	398	525
30	30.000	22.0	22.0	1008	1329
750	762.0	559	559	458	604
32	32.000	23.5	23.5	1151	1517
800	812.8	597	597	524	690
34	34.000	25.0	25.0	1302	1718
850	863.4	635	635	592	781
36	36.000	26.5	26.5	1464	1931
900	914.4	673	673	666	878
40	40.000	29.5	29.5	1823	2406
1000	1016.0	749	749	829	1094
42	42.000	30.0	27.0	1876	2476
1050	1066.8	762	711	853	1126
44	44.000	32.0	30.0	2111	2786
1100	1117.6	813	762	959	1266
48	48.000	35.0	33.0	2527	3339
1200	1219.2	889	838	1149	1518

Note: C-E / C-T to ANSI B16.9

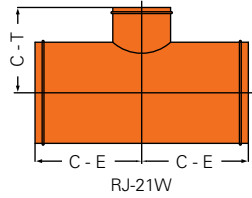

Nominal Size in / mm	Pipe OD in / mm	RJ-21W Reducing Tee			
		C - E in / mm	C - T in / mm	Weight (t = 0.375" / 9.5 mm) Lbs / Kgs	Weight (t = 0.5" / 12.7 mm) Lbs / Kgs
14 x 12	14.0 x 12.0	11.0	10.6	178	236
350 x 300	355.6 x 323.9	279	270	81	107
16 x 12	16.0 x 12.0	12.0	11.6	192	255
400 x 300	406.4 x 323.9	305	295	87	116
16 x 14	16.0 x 14.0	12.0	12.0	200	266
400 x 350	406.4 x 355.6	305	305	91	121
18 x 12	18.0 x 12.0	13.5	12.6	255	339
450 x 300	457.2 x 323.9	343	321	116	154
18 x 14	18.0 x 14.0	13.5	13.0	263	350
450 x 350	457.2 x 355.6	343	330	120	159
18 x 16	18.0 x 16.0	13.5	13.0	270	359
450 x 400	457.2 x 406.4	343	330	123	163
20 x 14	20.0 x 14.0	15.0	14.0	360	479
500 x 350	508.0 x 355.6	381	356	164	218
20 x 16	20.0 x 16.0	15.0	14.0	362	482
500 x 400	508.0 x 406.4	381	356	165	219
20 x 18	20.0 x 18.0	15.0	15.5	373	496
500 x 450	508.0 x 457.2	381	394	170	226
24 x 18	24.0 x 18.0	17.0	16.5	551	733
600 x 450	609.6 x 406.4	432	419	251	333
24 x 20	24.0 x 20.0	17.0	17.0	591	786
600 x 500	609.6 x 508.0	432	432	269	357
26 x 16	26.0 x 16.0	19.5	17.0	705	933
650 x 400	660.4 x 406.4	495	432	320	424
26 x 18	26.0 x 18.0	19.5	17.5	711	942
650 x 450	660.4x406.4	495	445	323	428
28 x 18	28.0 x 18.0	20.5	18.5	800	1060
700 x 450	711.2 x 457.2	521	470	364	482
28 x 20	28.0 x 20.0	20.5	19.0	807	1069
700 x 500	711.2 x 508.0	521	483	367	486
28 x 24	28.0 x 24.0	20.5	20.0	822	1089
700 x 600	711.2 x 609.6	521	508	374	495
30 x 20	30.0 x 20.0	22.0	20.0	924	1224
750 x 500	762.0 x 508.0	559	508	420	556
30 x 26	30.0 x 26.0	22.0	21.5	949	1256
750 x 65	762.0 x 660.4	559	546	431	571
32 x 24	32.0 x 24.0	23.5	22.0	1063	1408
800 x 600	812.8 x 609.6	597	559	483	641
32 x 28	32.0 x 28.0	23.5	22.5	1077	1426
800 x 700	812.8 x 711.2	597	572	489	648
34 x 26	34.0 x 26.0	25.0	23.5	1204	1595
850 x 650	863.4 x 660.4	635	597	547	725
34 x 30	34.0 x 30.0	25.0	24.0	1217	1612
850 x 750	863.4 x 762.0	635	610	553	733
36 x 24	36.0 x 24.0	26.5	24.0	1333	1767
900 x 600	914.4 x 609.6	673	610	606	803
36 x 28	36.0 x 28.0	26.5	24.5	1346	1785
900 x 700	914.4 x 711.2	673	622	612	811
36 x 32	36.0 x 32.0	26.5	25.5	1366	1811
900 x 800	914.4 x 812.8	673	648	621	823
40 x 28	40.0 x 28.0	29.5	26.5	1673	2215
1000 x 700	1016.0 x 711.2	749	673	761	1007
40 x 32	40.0 x 32.0	29.5	28.0	1698	2247
1000 x 800	1016.0 x 812.8	749	711	772	1021
40 x 36	40.0 x 36.0	29.5	29.0	1722	2279
1000 x 900	1016.0 x 914.4	749	737	783	1036
42 x 30	42.0 x 30.0	30.0	28.0	1791	2371
1050 x 750	1066.8 x 762.0	762	711	814	1078
42 x 34	42.0 x 34.0	30.0	28.0	1804	2388
1050 x 850	1066.8 x 863.4	762	711	820	1086
44 x 32	44.0 x 32.0	32.0	28.0	1984	26267
1100 x 800	1117.6 x 812.8	813	711	902	1194
44 x 36	44.0 x 36.0	32.0	28.5	1999	2647
1100 x 900	1117.6 x 914.4	813	724	909	1203

Nominal Size in / mm	Pipe OD in / mm	RJ-21W Reducing Tee			
		C - E in / mm	C - T in / mm	Weight (t = 0.375" / 9.5 mm) Lbs / Kgs	Weight (t = 0.5" / 12.7 mm) Lbs / Kgs
44 x 40	44.0 x 40.0	32.0	29.5	2023	2679
1100 x 1000	1117.6 x 1016.0	813	749	920	1218
48 x 36	48.0 x 36.0	35.0	31.0	2371	3140
1200 x 900	1219.2 x 914.4	889	787	1078	1427
48 x 40	48.0 x 40.0	35.0	32.0	2395	3172
1200 x 1000	1219.2 x 1066.8	889	813	1089	1442
48 x 44	48.0 x 44.0	35.0	33.0	2421	3207
1200 x 1100	1219.2 x 1117.6	889	838	1101	1458

Note: C-E / C-T to ANSI B16.9

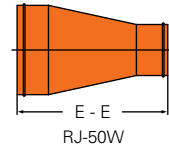

Nominal Size in / mm	Pipe OD in / mm	E - E in / mm	RJ-50W Concentric Reducer	
			Weight (t = 0.375" / 9.5 mm) Lbs / Kgs	Weight (t = 0.5" / 12.7 mm) Lbs / Kgs
26 x 16	26.0 x 16.0	24	178	236
650 x 400	660.4 x 406.4	610	81	107
26 x 18	26.0 x 18.0	24	184	245
650 x 450	660.4x406.4	610	84	112
28 x 18	28.0 x 18.0	24	194	259
700 x 450	711.2 x 457.2	610	88	118
28 x 20	28.0 x 20.0	24	201	268
700 x 500	711.2 x 508.0	610	92	122
28 x 24	28.0 x 24.0	24	215	286
700 x 600	711.2 x 609.6	610	98	130
30 x 20	30.0 x 20.0	24	211	281
750 x 500	762.0 x 508.0	610	96	128
30 x 26	30.0 x 26.0	24	233	309
750 x 65	762.0 x 660.4	610	106	141
32 x 24	32.0 x 24.0	24	235	313
800 x 600	812.8 x 609.6	610	107	142
32 x 28	32.0 x 28.0	24	249	331
800 x 700	812.8 x 711.2	610	113	150
34 x 26	34.0 x 26.0	24	252	335
850 x 650	863.4 x 660.4	610	114	152
34 x 30	34.0 x 30.0	24	265	352
850 x 750	863.4 x 762.0	610	120	160
36 x 24	36.0 x 24.0	24	257	341
900 x 600	914.4 x 609.6	610	117	155
36 x 28	36.0 x 28.0	24	268	356
900 x 700	914.4 x 711.2	610	122	162
36 x 32	36.0 x 32.0	24	283	376
900 x 800	914.4 x 812.8	610	129	171
40 x 28	40.0 x 28.0	24	299	398
1000 x 700	1016.0 x 711.2	610	136	181
40 x 32	40.0 x 32.0	24	310	412
1000 x 800	1016.0 x 812.8	610	141	187
40 x 36	40.0 x 36.0	24	323	430
1000 x 900	1016.0 x 914.4	610	147	195
42 x 30	42.0 x 30.0	24	318	422
1050 x 750	1066.8 x 762.0	610	144	192
42 x 34	42.0 x 34.0	24	329	437
1050 x 850	1066.8 x 863.4	610	149	199
44 x 32	44.0 x 32.0	24	334	444
1100 x 800	1117.6 x 812.8	610	152	202
44 x 36	44.0 x 36.0	24	345	459
1100 x 900	1117.6 x 914.4	610	157	209
44 x 40	44.0 x 40.0	24	358	477
1100 x 1000	1117.6 x 1016.0	610	163	217
48 x 36	48.0 x 36.0	28	422	561
1200 x 900	1219.2 x 914.4	711	192	255
48 x 40	48.0 x 40.0	28	438	582
1200 x 1000	1219.2 x 1066.8	711	199	265
48 x 44	48.0 x 44.0	28	453	602
1200 x 1100	1219.2 x 1117.6	711	206	274

Note: E-E to ANSI B16.9



Max. Internal Service Pressure of Carbon Steel Pipe, ASTM A53 Gr. B

When designing a piping system you must select pipe with the appropriate wall thickness to correspond with the intended working pressure of the system. The table lists design working pressure by the pipe wall schedule, XS, STD and LW, of representative ASTM A53 Gr. B carbon steel pipe calculated in accordance with the formula stipulated in ASME B31.1 Power Piping para. 104.1.

$$P = \frac{2SE (tm-A)}{Do - 2y (tm - A)}$$

Where:

- P = Maximum internal service pressure (psi)
- SE = Allowable stress (psi)
(ASTM A53 Gr. B = 15,000 psi)
- tm = Minimum pipe wall thickness (inch)
(87.5% of nominal wall thickness)
- Do = Outside diameter of pipe (inch)
- y = A coefficient (For ferritic steels 600°F or below = 0.4)
- A = Additional thickness (inch) (A = 0)

Max. Internal Service Pressure of Carbon Steel Pipe, ASTM A53 Gr. B

Unit: psi

Nominal Size in / mm	XS 0.5"	STD 0.375"*	LW 0.25" / 0.312"^
8 / 200	1586	1006	777
10 / 250	1262	913	621
12 / 300	1058	788	522
14 / 350	962	717	475
16 / 400	839	625	415
18 / 450	744	555	368
20 / 500	668	499	331
24 / 600	555	415	275
26 / 650	512	382	318
28 / 700	475	355	295
30 / 750	443	331	275
32 / 800	415	310	258
36 / 900	368	275	229
38 / 950	349	261	217
40 / 1000	331	248	206
42 / 1050	315	236	187
44 / 1100	301	225	
48 / 1200	275	206	
52 / 1300	254	190	
54 / 1350	245	183	
56 / 1400	236	177	
60 / 1500	220	165	
66 / 1650	200	150	
68 / 1700	194	145	
72 / 1800	183	137	
84 / 2100	157	118	
96 / 2400	137	103	

Except *8": 0.322"

^ 8" ~ 24": 0.25", 26" ~ 42": 0.312"

Material Specifications

Housing

Ductile Iron: Per ASTM A536 Gr. 65-45-12, and/or ASTM A395 Gr. 65-45-15 minimum tensile strength 65,000 psi or 448 MPa. **Paint:** Orange or RAL3000 red. **Optional:** Hot-dip galvanized, epoxy coating or polyamid 11 (Nylon) coating is also available upon request.

Hardware

Bolts: Carbon steel heat-treated track bolts to ASTM A183 Gr. 2.

Nuts: Carbon steel heavy duty nuts to ASTM A563. Both bolts and nuts are UNC threaded and electro zinc plated.

Weld Rings

Factory supplied end rings are made of carbon steel per SAE J403 (ANSI) 1020. **Optional:** Stainless steel rings: Type 304, 316 or 316L available upon request.

Gasket

Always specify the desired compound (Grade) at time of order

Compound	EPDM (Grade E)	Nitrile (Grade T)
Color Code	Green stripe	Orange stripe
Temperature Range	-29°F to +230°F (-34°C to +110°C)	-20°F to +180°F (-29°C to +82°C)
Applications	Recommended for cold and hot water services, water with chlorine, deionized water, seawater, waste water, dilute acids, oil-free air and many other chemicals Caution: Not recommended for petroleum oils, mineral oils, solvents and aromatic hydrocarbons	Recommended for petroleum oils, mineral oils, vegetable oils, aromatic hydrocarbons, many acids and water up to +150°F (+65°C)

Note: Other gasket options are also available.

Angular deflection: The R-88 coupling is designed to provide a restrained joint with a controlled range of angular deflection (flexibility). The degree of deflection is influenced by several factors including; pipe, fitting and component dimensions, pipe end squareness, ring location, weld size and system pressure. When designing a piping system these considerations should be factored into the system. When designing a system requiring increased deflection (flexibility) please contact **Shurjoint** for customized solutions.

As with all piping systems proper support, anchoring and bracing are essential. Industry standard requirements such as B31.1 (Power Piping), B31.9 (Building Services) and B31.11 (Slurry Transportation), etc. should be followed for your specific type of pipeline system application.

Installation Instructions

1. Mounting factory supplied weld rings: Mount the factory supplied weld ring on the pipe end using the *Shurjoint* ring clamp, C-clamp or other device to secure and position the ring in place. **Prior to welding make sure that the "L" dimension (the distance between the pipe end and the ring) is as specified for the coupling / pipe size.**

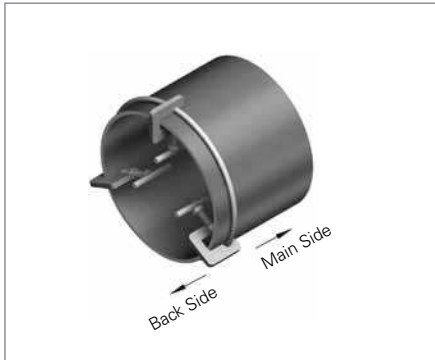

2. Step one welding: First weld the butt ends of the ring together. Next tack weld the ring to the pipe at several locations. Remove the ring clamps or other positioning devices.



3-1. Step two welding: Determine the type of weld required, full or partial, depending on the intended system working pressure. Refer to page 11 for working pressures and full and partial welding information. Weld the ring to the pipe using the proper weld(s) for the intended service.

Full & Partial Ring Welding: The *Shurjoint* Model R-88 Ring Joint Coupling is supplied with factory weld rings and is designed for a variety of service and pressure applications. For lower pressure applications weld rings need not be fully welded around the entire circumference of the pipe. The table shows the minimum required weld length in inches or millimeters and corresponding working pressures. Working pressures are based on the use of applicable pipe wall thickness for the service pressure intended.

Full welding means both sides of the weld ring are fully welded around the circumference of the pipe. One side shall be referred to as the "Main Weld" and the other side as "Back Weld". Either side of the weld ring can receive the Main Weld.



Ring Clamp

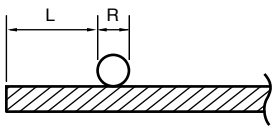

Welding conditions:

Method: SMAW (Shielded metal arc welding)*

Electrode: Flux-cored electrode $\frac{3}{32}$ " (2.4mm) to $\frac{1}{8}$ " (3.2mm)

Welding speed: 12" (300mm) to 16" (400mm) per minute

Current: 110A – 160A

Rotate pipe so that you can keep your electrode holder at the same position.

*GTAW or FCAW is also acceptable.

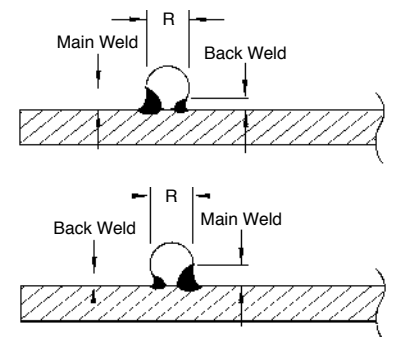
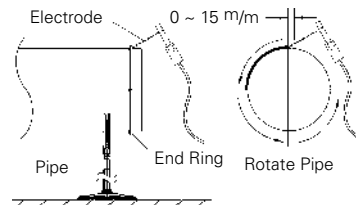

3-2. Partial weld: Partial ring welding will provide sufficient strength for lower pressure services. In case of partial ring welding, the weld shall be processed on the backside (away from the pipe end) of the ring.

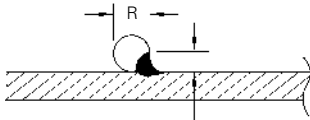

An equal alternating or zigzag weld is acceptable. Welds should be equal length and evenly spaced. Back welding provides additional strength to a partial weld.

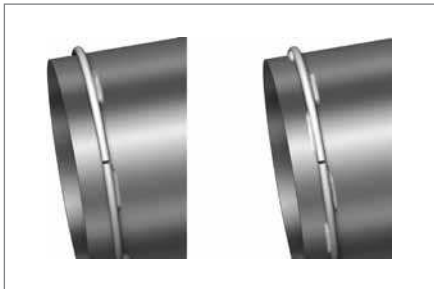

The fillet size of the Main Weld should measure a minimum of one half of the end ring size. The Back Weld should measure a minimum of one half of the Main Weld size.

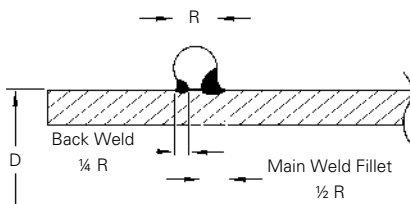

Standard End Ring & Fillet Size

Unit: Inch (mm)

End Ring Size	Main Weld Size	Back Weld Size
1/4 (6.0)	1/8 (3.0)	1/16 (1.5)
9/32 (7.0)	9/64 (3.5)	9/128 (1.75)
5/16 (8.0)	5/32 (4.0)	5/64 (2)
3/8 (9.5)	3/16 (4.8)	3/32 (2.4)
1/2 (12.0)	1/4 (6.0)	1/8 (3)
5/8 (16.0)	5/16 (8.0)	5/32 (4)
3/4 (19.0)	3/8 (9.5)	3/16 (4.75)

Working Pressure / Full & Partial Ring Welding

Minimum required weld length in inches (mm) and corresponding working pressures in psi (bar) for applicable steel pipe*.

Nominal Size in / mm	Weld Length - in / mm			
	< 125 psi < 9 bar	< 175 psi < 12 bar	< 300 psi < 20 bar	350 psi < 24 bar <
8 / 200	10 / 254	14 / 356	20 / 508	Full
10 / 250	12 / 305	20 / 508	30 / 762	Full
12 / 300	16 / 406	24 / 610	36 / 914	Full
14 / 350	18 / 457	28 / 711	40 / 1016	Full
16 / 400	22 / 559	32 / 813	Full	Full
18 / 450	28 / 711	40 / 1016	Full	Full
20 / 500	30 / 762	44 / 1118	Full	Full
24 / 600	40 / 1016	56 / 1422	Full	Full
26 / 650	42 / 1067	60 / 1524	Full	Full
28 / 700	44 / 1118	62 / 1575	Full	Full
30 / 750	48 / 1219	70 / 1778	Full	Full
32 / 800	50 / 1270	76 / 1930	Full	Full
34 / 850	54 / 1372	80 / 2032	Full	Full
36 / 900	68 / 1727	88 / 2235	Full	Full
38 / 950	76 / 1930	94 / 2388	Full	Full
40 / 1000	78 / 1981	102 / 2591	Full	Full
42 / 1050	81 / 2057	106 / 2692	Full	Full
44 / 1100	90 / 2286	114 / 2896	Full	Full
48 / 1200	110 / 2794	130 / 3302	Full	Full
52 / 1300	136 / 3454	Full	Full	Full
54 / 1350	140 / 3556	Full	Full	Full
56 / 1400	150 / 3810	Full	Full	Full
60 / 1500	164 / 4166	Full	Full	Full
66 / 1650	Full	Full	Full	Full
68 / 1700	Full	Full	Full	Full
72 / 1800	Full	Full	Full	Full
84 / 2100	Full	Full	Full	Full
96 / 2400	Full	Full	Full	Full

1. Applicable to Model R-88 couplings only.
2. "Full" welding means both sides of the weld ring are fully welded, all others are welded one side only.
3. * Refer to Max. Internal Service Pressure of Carbon Steel Pipe, ASTM A53 Gr. B table on page 9.

4. Quick check guide: After welding use an R-88 housing segment as a gauge to check the weld size by ensuring full and smooth engagement. The housing ring pocket must fully engage the ring without interference from the weld or fillet material.



Housing Segment

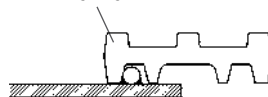

Quick Check

Fillets unacceptable:

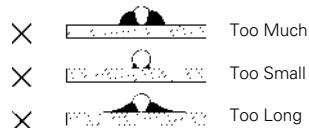

5. Weld the second ring: Repeat step 3 and weld the second ring to the other pipe end to be connected.



6. Apply a rust prevention coating: After welding apply a thin smooth coat of a rust prevention resin paint coating to the rings, weld areas and pipe ends. A fast drying paint is preferred.

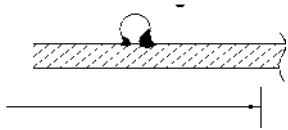

8. Align the pipe ends to be connected: Bring the mating pipes together and align the pipe ends. Turn the gasket back over the ring and center the gasket over the pipe ends and between the rings.

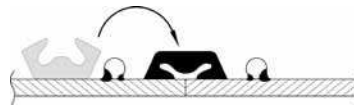

10. Tighten bolts and nuts: Install all bolts and nuts hand tight making sure the oval neck of the bolt fully engages into the housing bolt hole. Tighten nuts alternately and equally until all bolt pads come metal to metal.



Recommended Torque

Bolt size x number	Lbs - Ft (Nm)
5/8" x 6	100 - 130 (136 - 176)
3/4" x 6	150 - 200 (203 - 271)
7/8" x 8	180 - 220 (244 - 298)
1" x 16	200 - 250 (271 - 339)
1 1/4" x 16	250 - 350 (339 - 475)
1 1/2" x 16	350 - 500 (475 - 678)

Note: For systems subject to vibration or movement the use of Belleville washers or periodic checks to ensure tightness of bolts and nuts are recommended.

7. Lubricate and install gasket: Apply a thin coat of *Shurjoint* lubricant to the gasket exterior and sealing lips. Install the gasket over one pipe end. Turn the gasket inside out over the ring.



9. Install the coupling segments: Place the coupling segments over gasket so that the housing engages both rings. For larger size couplings, multiple segments can be loosely pre-assembled to aid in installation.



Warning – Always depressurize and drain the piping system before attempting to install, remove, adjust, or repair any *Shurjoint* piping component. Failure to comply with these instructions could lead to joint failure or resulting in serious personal injury, product and or property damage.



NOTE:
Non-destructive testing is not required by *Shurjoint*. Proper assembly of the rings, to which this would fall under, is the responsibility of the contractor/installer and is ultimately their decision regarding any standard, testing, or qualification of the welding personnel. Generally accepted piping and welding practices should be followed.

Project Pictures



72" (1800mm) Model R-88 couplings used in a domestic water treatment plant, Ontario, Canada



36" (900mm) Model R-88 couplings used in an HVAC chilled water line for a major university, Saudi Arabia



12" (300mm) & 14" (350mm) R-88 couplings used in tunnel boring / mining application. The pipe line delivered a bentonite water mixture while the outflow was an aggressive rock and mud slurry, Portland, Oregon, USA



24" (600mm), 36" (900mm) and 48" (1200mm) Model R-88 Couplings with stainless steel rings used on stainless steel hydro electric pipe line, Vernon, British Columbia, Canada



48" (1200mm) Model R-88 couplings used in a water treatment plant, Quarry, Utah, USA



Shurjoint Piping Products

4775 East Cheyenne Ave., Suite 100
Las Vegas, Nevada 89115
USA
Tel: 702-644-4492
Fax: 702-644-1091
Toll Free: 1-877-GROOVED
1-877-476-6833
E-mail: world@shurjoint.com

Shurjoint Piping Products

1380 Beverage Drive, Suite P
Stone Mountain, Georgia 30083
USA
Tel: 770-817-0444
Fax: 770-817-0443
Toll Free: 1-877-880-6600

Shurjoint Piping Products

3F 130 Xinhua 3rd Road, (Neihu)
Taipei, Taiwan
Tel: 886-2-2792-7929
Fax: 886-2-2792-5159

Your local distributor is: _____

Job Name: _____ Contractor: _____

Job Location: _____ Approval: _____

Job Number: _____ Engineer: _____

Representative: _____ Approval Date: _____

Shurjoint specifications and/or designs are subject to change without notice and/or obligation.

No. F001RS-13 © Copyright 2013 Shurjoint

Shurjoint product specifications in U.S. customary units and metric are approximate and are provided for reference only. For precise measurements, please contact Shurjoint Technical Service. Shurjoint reserves the right to change or modify product design, construction, specifications, or materials without prior notice and without incurring any obligations to make such changes and modifications on Shurjoint products previously produced or sold.